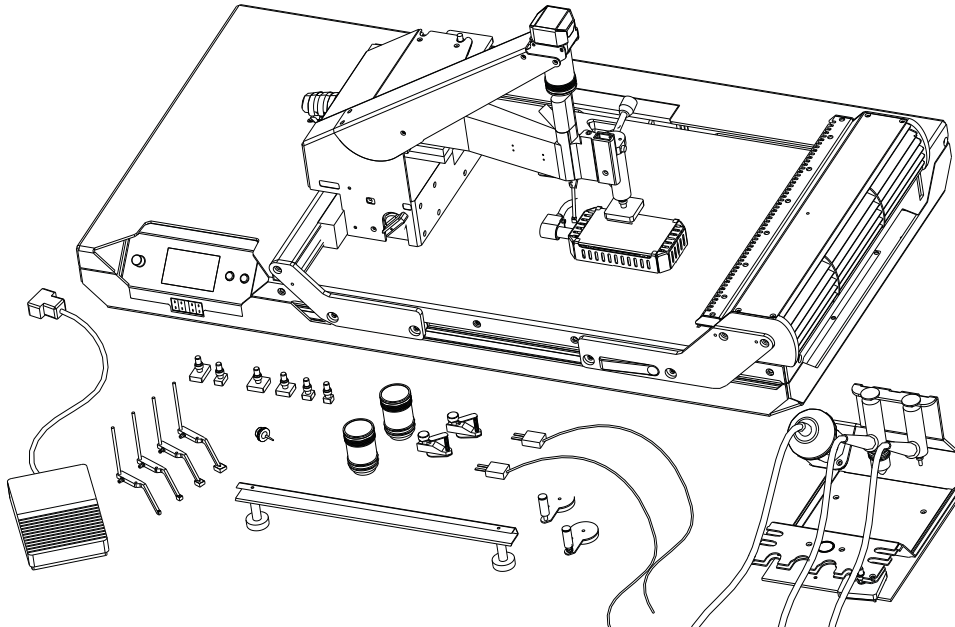

**Rework Technic – EXPERT 10.6-IV**

**Rework Station with IR-Underheater 110W (60x80mm<sup>2</sup>) and automated SMD placement process by Auto Vision Placer (AVP), incl. Easy Solder software package and DBL 06 control unit with six high resolution sensor inputs for thermocouples (Type K).**

**This system is particularly suitable for small PCBs which you can find in Smartphones and PDAs with Fin Pitch components in varying package dimensions.**

**Standard Equipment (Art.No. DB00.1068)**

- Tool set for dispensing, placing, residual solder removal and soldering with magazine.
- Set of placement nozzles (BGA/CSP) 3mm, 5mm, 8mm, 10mm
- Set of soldering nozzles (CSP/QFN), 9mm, 11mm 13mm, 16mm
- Set of soldering nozzles (SO) 10x15mm<sup>2</sup>, 15x25mm<sup>2</sup>
- Placement nozzle for manual placement of small components (0,5mm)
- Two camera lenses (BGA und CSP)
- Two thermo couple sensors (Type K)
- Two PCB magnet holder 40,5mm (standard)
- PCB magnet holder rail 40,5mm
- Two PCB clips to install at hand rest
- Foot switch
- Rework ABC and manual







**Technical Data**

System power consumption:	1000 VA	
Power solder pen:	300 W, 35 l/min	
Power underheater:	110 W, 2 x IR lamps	
Effective heating area:	60 x 80 mm <sup>2</sup>	
Recommended PCB size max:	80 x 100 mm <sup>2</sup>	
Resolution motion system:	0,001 mm	
Placement accuracy :	± 0,015 mm	(Flip Chip)*
	± 0,030 mm	(CSP)
	± 0,040 mm	(BGA)
High resolution CMOS-camera:	5 Mio. Pixel, USB2	
	14 x 18 mm <sup>2</sup>	(Flip Chip)*
	28 x 37 mm <sup>2</sup>	(CSP)
	37 x 50 mm <sup>2</sup>	(BGA)
Mains:	1 Phase, 230VAC, Fuse 16A	
Pressurized air:	5 - 8 bar, 100l/min clean dry air	
Foot print:	460 x 865 mm <sup>2</sup>	

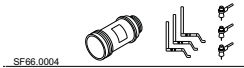
\*Optional Extras

## Rework Technic – EXPERT 10.6-IV

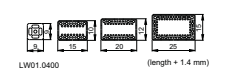
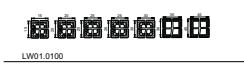
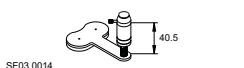
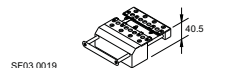
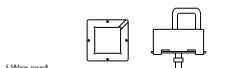
### Optional extras

SF66.0004	Micro SMD nozzles and lens for AVP 4 licence MS, 3 n, 3 solder n, lens FC		1 piece
DVSX.0007	Report with pcb identification for ES 05, licence RP		1 piece
SF66.0110	Lens Maxi BGA for AVP4/4XL, f=16mm, 65*85mm		1 piece
LW40.1099	Solder nozzle set BGA 7 for all (98%) types of BGA, 7 pieces		1 piece
LW01.0400	Soldering tool set SO (lead free)* for all SO...SOL...TSOP, 4 pieces		1 piece
LW01.0100	Soldering tool set QFP for all PLCC ...QFP, 7 pieces		1 piece
SF03.0014	PCB magnet holder Easy Lock 40.5 (snap) for IR/IRD/IRH/IRF radiation element		1 piece
SF03.0019	PCB clamping holder 40.5 with 3 fingers for mobil phone pcs on HB05/IR/IRD/IRH/IRF		1 piece
LWxx.xxx4	Reballing oven and masks for all types of BGA/CSP, your choice		1 piece
SF71.0001	Side Camera for ES 05, camera, stand, cable, DVD		1 piece
DB00.0025	Nitrogen input for DBL 04/05/06 (2.p.r) reduces consumption of N2 for vacuum		1 piece