

**Rework Technic – EXPERT 04.6-IH**

Rework Station with 110W heating power in IR-Technology over an area of 65x80mm<sup>2</sup>. Placement of SMD Chips with Star Tool Technology, incl. Easy Solder software package and Hot Air 05 control unit. The rework set comes together with additional tools for old solder removal and dispensing. It has four high resolution sensor inputs for thermo-couples (Type K).

The machine is a cost optimized solution for manual rework of small PCBs, i.e. for smart phones.

**Standard Equipment (Art.No. HA00.4080)**

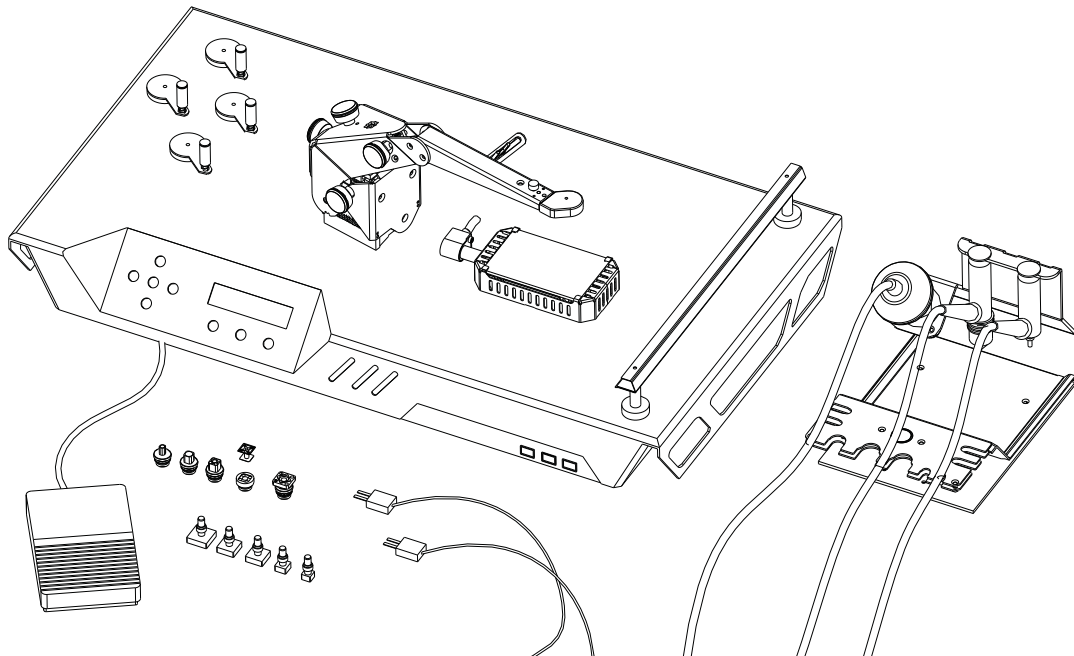



- Set of three tools with magazine for soldering, dispensing, residual solder removal and placing
- Set of placement nozzles for SHP arm (6 pieces)
- Set of soldering tools (CSP/QFN), 9x9mm<sup>2</sup>, 11x11mm<sup>2</sup>, 13x13mm<sup>2</sup>, 16x16mm<sup>2</sup> and (QFP) 15x15mm<sup>2</sup>
- Two thermo couple sensors (Type K)
- Four PCB magnet holder 40,5mm (standard)
- PCB magnet holder rail 40,5mm
- Foot switch
- Rework ABC and manual

**Technical Data**

System power consumption :	600 VA
Power soldering pen:	300 W, 35 l/min
Power under heater:	30-110 W, 2 x IR-Lamps
Effective heating area:	60 x 80 mm <sup>2</sup>
Recommended max. PCB size:	80 x 100 mm <sup>2</sup>
Placement accuracy:	± 0,1 mm
Mains:	1 Phase, 230VAC, fused 16A
Pressurized air:	5-8 bar, 100 l/min clean dry air
Footprint:	600 x 360 mm <sup>2</sup>

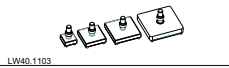
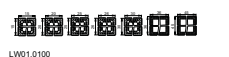
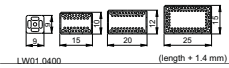
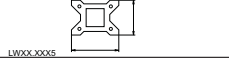
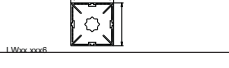
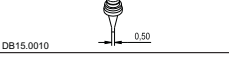
## Rework Technic – EXPERT 04.6-IH

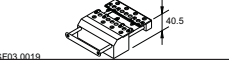
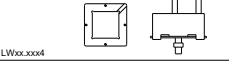
### Optional Extras

HASX.0008	Report for ES-05 eco licence RP	
LW40.1103	Solder nozzle set BGA 4 4 pieces (15, 27, 35, 40)	
LW01.0100	Soldering tool set QFP for all PLCC ...QFP, 7 pieces	
LW01.0400	Soldering tool set SO (lead free)* for all SO...SOL...TSOP, 4 pieces	
LWxx.xxx5	Placement tool Star Tool CSP/QFN for all types of CSP/QFN, your choice	
LWxx.xxx6	Placement tool Star Tool BGA for all types of BGA, your choice	
DB15.0010	SMD placement nozzle, 0,5 mm for 0402 etc	
SF01.0100	PCB clip for large pcbs onto IRF handrest	
SF03.0019	PCB clamping holder 40.5 with 3 fingers for mobil phone pcbs on HB05/IR/IRD/IRH/IRF	
LWxx.xxx4	Reballing oven and mask for all types of BGA/CSP, your choice	
VD90.4001	Microscope with arm and illumination 5x - 22x (zoom 4.4), 46 - 10mm, 150mm	
HA00.4025	Nitrogen input for Hot Air 04/05 reduces consumption of N2 for vacuum	