

**EXPERT 04.6-HH**

Rework Station with 3000W hybrid under heater. The heating area of 275x245mm<sup>2</sup> is adjustable to PCB size. Manual SMD placement process by Single Head Placer (SHP) incl. Easy-Solder eco software package and Hot Air 06 control unit with two high resolution sensor inputs for thermocouples (Type K).

This system is particularly suitable for simple rework applications on mid-size multilayer PCB's with the demand of power full underheater.

**Standard Equipment (Art.No. HA00.4090)**

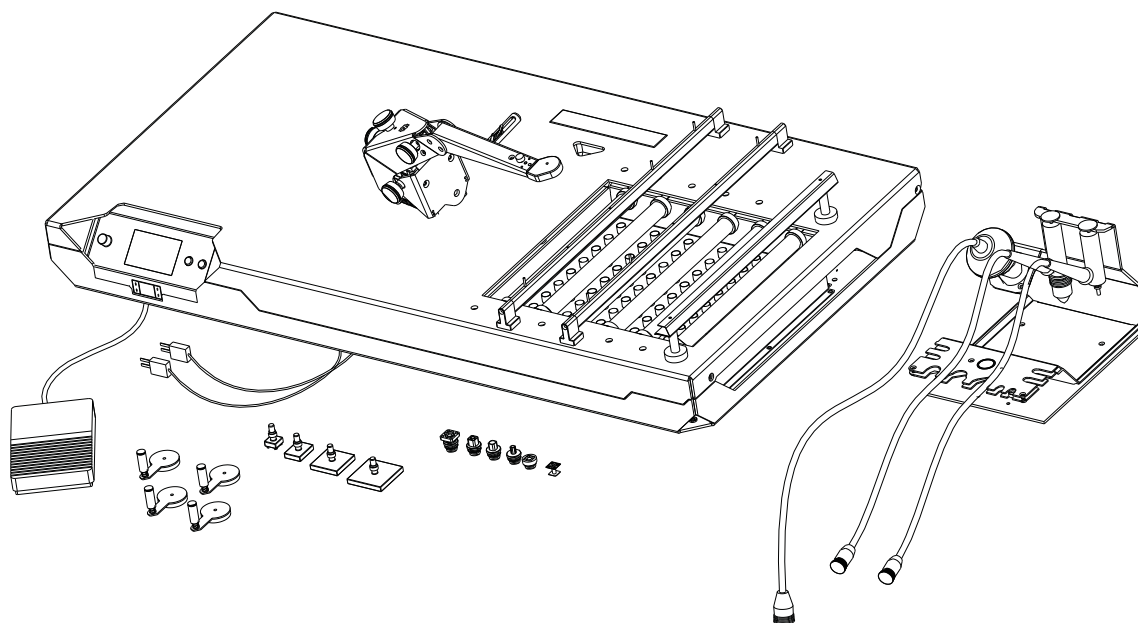









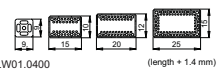
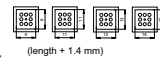

- Tool set for dispensing, placing and soldering with magazine
- Set of placement nozzles for SHP arm (6 pcs)
- Set of solder nozzles (BGA) 15mm, 27mm, 35mm 40mm
- Two thermo couple sensors (Type K)
- Four PCB magnet holder 40.5mm (standard)
- PCB Magnet holder rail 40.5mm
- Two PCB supports 40.5mm, 5-pins
- Foot switch
- Rework ABC and manual

**Technical Data**

System power consumption:	3500 VA
Power solder pen:	300 W, 35 l/min
Power underheater:	600-3000 W, 6 x IR-lamps
Effective heating area	275 x 245 mm <sup>2</sup>
Recommended max. PCB size:	305 x 305 mm <sup>2</sup>
Mains:	1 Phase, 230VAC, Fuse 16A Connector Type CEE 32A (3 phase)
Pressurized air	5-8 bar, 100 l/min clean dry air
Foot print:	865 x 460 mm <sup>2</sup>

## EXPERT 04.6-HH

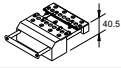
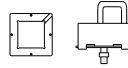
### Optional Extras

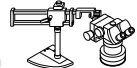
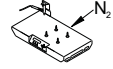
HASX.0008	Report for ES-05 eco licence RP	
LW40.1099	Solder nozzle set BGA 7^ for all (98%) types of BGA, 7 pieces	
LW01.0100	Soldering tool set QFP for all PLCC ...QFP, 7 pieces	
LW01.0400	Soldering tool set SO (lead free)* for all SO...SOL...TSOP, 4 pieces	
LW40.1097	Soldering nozzle set CSP/QFN (lead free)* for all CSP types, 4 pieces (9, 11, 13, 16)	
LWxx.xxx5	Placement tool Star Tool CSP/QFN for all types of CSP/QFN, your choice	
LWxx.xxx6	Placement tool Star Tool BGA for all types of BGA, your choice	
DB15.0010	SMD placement nozzle, 0,5 mm for 0402 etc	
LW10.0002	CSP centering device for Star Tools (rotates)	
SF36.1001	PCB flex support 40.5 for HIF 08 and IRF, "10 pin"	
SF01.0100	PCB clip for large pcbs onto IRF handrest	
SF03.0014	PCB magnet holder Easy Lock 40.5 (snap) for IR/IRD/IRH/IRF/HIF	
SF03.0019	PCB clamping holder 40.5 with 3 fingers for mobile phone pcbs on HB05/IR/IRD/IRH/IRF/HIF	
LWxx.xxx4	Reballing oven and mask for all types of BGA/CSP, your choice	
SF71.0001	Side Camera for ES 05, camera, stand, cable, DVD	
VD90.4001	Microscope with arm and illumination 5x - 22x (zoom 4.4), 46 - 10mm, 150mm	
HA00.4025	Nitrogen input for Hot Air 04/05 reduces consumption of N2 for vacuum	
SF00.0028	Line connector CEE 32 A for HIF 08/09 / IRF 07 with hints	